

Product Appearance

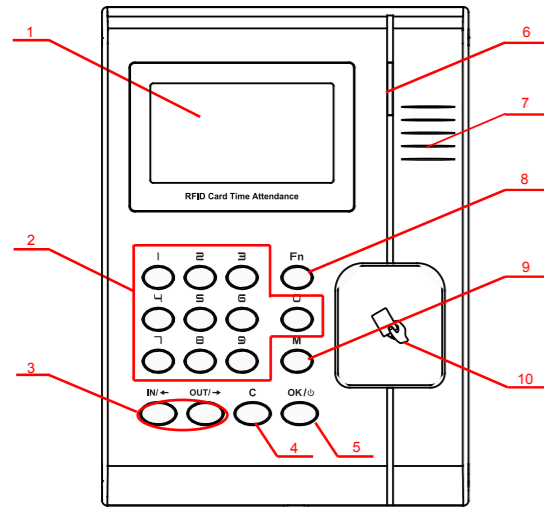

- 1.LCD
- 2.0-9 Num.Key
- 3.State Key/ Page (Up/Down)
- 4.Delete/Exit Key
- 5.Confirm/Power Key
- 6.LED
- 7.Speaker
- 8.Work Coder Key
- 9.Menu Key
- 10.Swipe Card Area

Menu list

Press [OK] about 3 seconds to turn on the terminal, press [M] key to enter the management menu. Menu list:

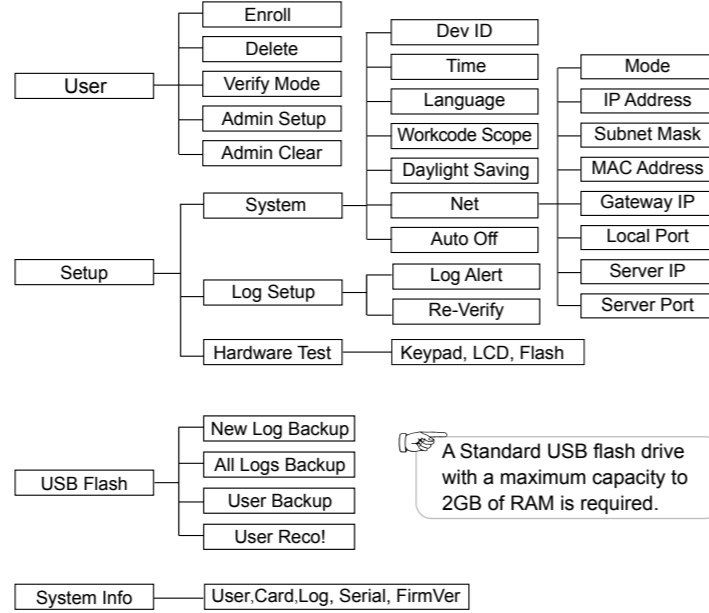

A Standard USB flash drive with a maximum capacity to 2GB of RAM is required.

Other Setup

Verify Mode:

Item	Explanation
Any	Card Or Password only
RF+PW	It requires both Card and Password Verification together
Factory default Setting	Any

Device ID:

Item	Explanation
0-9999999	Device ID of the unit which is required in software communication
Factory default Setting	1

Tips:Device ID of the unit which is required in software communication When the ID as "0" please use the last 8 digits of the serial number.

Language:

Item	Explanation
Language	Contains 11 languages: ENG(English),FRCH(French),GERM(German),SPAN(Spanish),PTG(Portuguese),ITA(Italian),BULG(Bulgarian),SLVK(Slovak),HUNG(Hungarian),SLVN(Slovenian),TURK(Turkish)
Factory default Setting	Related Language

WorkCode:

Item	Explanation
0-999999	Valid scope for the Workcode
Factory default Setting	MAX 999999 MIN 0

Tips:WorkCode indicates the work type,easily distinguishes which attendance record is related which work type.

Net:

Item	Explanation	Factory default Setting
Mode	TCP/IP Server mode:Common network mode TCP/IP Client mode:Only communicate With the PC which has static IP	Server mode
IP Address	Set terminal IP address when communication of TCP/IP,IP address must be a static IP address	192.168.0.218
Subnet Mask	Subnet Mask of the LAN	255.255.255.0
MAC Address	Unique Physical address of the network module.This setting can not be modified	
Gateway IP	Default Gateway of the LAN	192.168.0.1
Port	Net work communication port	5010
Server IP	The IP address of the Sever Machine when using Client Mode TCP/IP communication	192.168.0.7
Server Port	It's the software port number when access control is under TCP/IP communication	5010

USB Flash:

Item	Explanation
New Rec.Backup	Download new T&A records to U pan drive
All Rec.Backup	Download all T&A records to U pan drive
User Backup	Download employee's records saved in device to U pen drive
User Recovery	Upload employee's information saved in U pen drive to terminal

Auto off,LogAlert,Re-Verify:

Item	Explanation
Auto off	Set the time duration from the last operation to the dormant state No-[Not Off],250min-[Max Time]
Log Alert	The terminal will alarm when the memory capacity is less than the [Log Alert] value.[No]-Not alarm,Max.value 5,000
Re-Verify	The duration of time in which the terminal will ignore repeated attempts for authentication.[No]: Disable the function; Max. value is 250 min

Operation Guide

- Enroll User: Each user can register one RFID Card and one password.

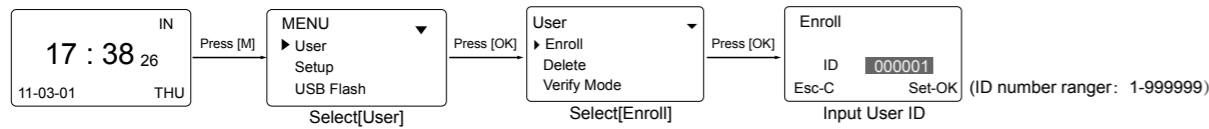

- Enroll Card :

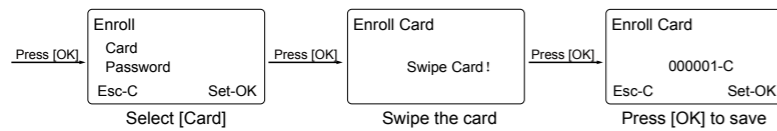

- Enroll Password: Password length: 0-999999

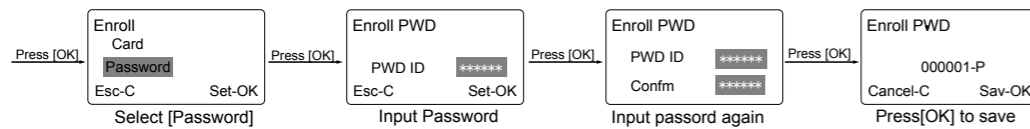

- Admin Setup: Admin(Administrator) has all the privileges of the machine. Please pay attention to the admin setup.

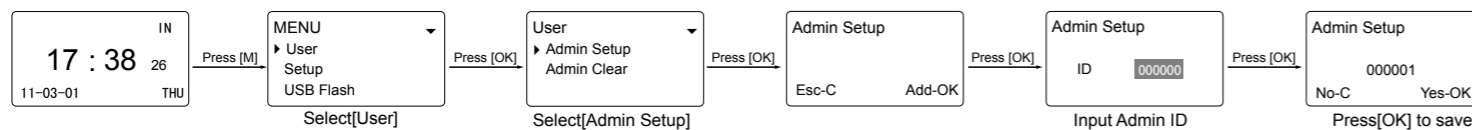

- Setup System Time: (Recommended:Please synchronize the time after connect with software.)

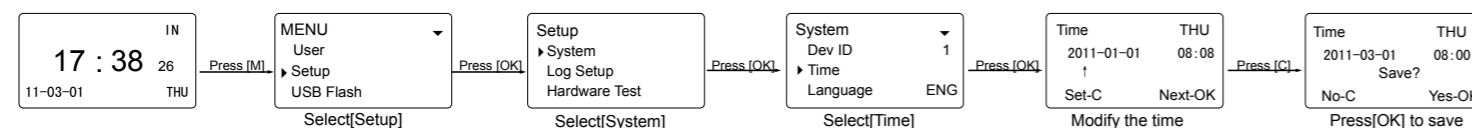

Wiring Diagram

